



  
Montie Gear™  
2014 Catalog

800.722.7987

# SHOOTING RESTS

Range bag weighing you down? Drop your heavy bench rest for a Montie Gear Shooting Rest, the industry's lightest. Built for portability, all models assemble and collapse in seconds.

## Shooting Rests

- lightweight 8.5 - 24 oz
- 3 point contact for stability
- compatible with a variety of firearms
- weatherproof



AR - Rest LIGHTWEIGHT  
MD100006  
\$59.95  
18.5 oz



Precision Rest  
MD100007  
\$399.95  
24 oz

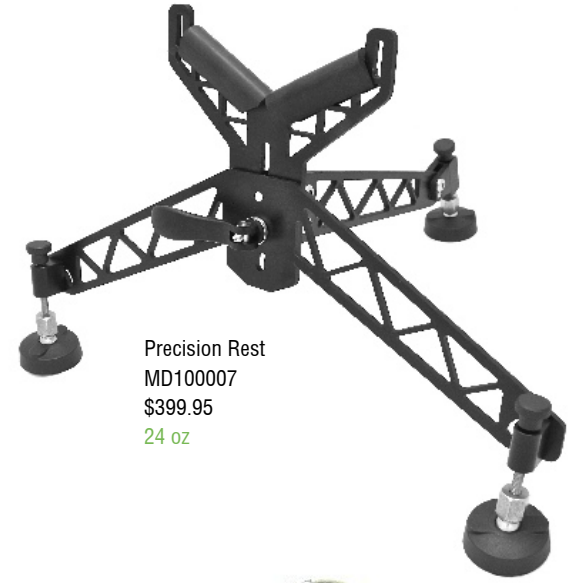

Tree Rest  
MD100008  
\$59.95  
8.5 oz



AR - Rest  
MD100005  
\$59.95  
18.5 oz



X - Rest LIGHTWEIGHT  
MD100004  
\$74.95  
10 oz



X - Rest  
MD100002  
\$49.95  
16 oz



Rear Rest LIGHTWEIGHT  
MD100018  
\$79.95  
8 oz



# CAMP KITCHEN GEAR

Scrap the trail mix and the granola bars for the Montie Gear mobile Camp Kitchen. Our wide range of products provide the ultimate cooking experience away from home.

## Solo Utensil Drying Rack

- holds cookware off the ground to keep it clean
- damage-free mounting to trees
- lightweight and portable
- quick setup (no tools necessary for assembly)

## Base Camp Utensil Drying Rack

- holds 6 cooking utensils

## Base Camp Spoon/Fork Drying Rack

- holds 15 Spoons or Forks



Solo Utensil Drying Rack  
MD100087  
\$39.95



Base Camp Utensil Drying Rack  
MD100102  
\$39.95



Base Camp Spoon/Fork Drying Rack  
MD100101  
\$39.95



# CAMP KITCHEN

## Camping Shelf

- damage-free mounting to trees
- easily hang items underneath
- lightweight and portable
- no tools required for assembly
- food-grade cutting board

## Camp Rack

- holds cookware off the ground
- damage-free mounting to trees
- lightweight and portable
- no tools required for assembly

## Towel Holders

- hangs a variety of items anywhere
- lightweight

## Tree Mounting Point

- lightweight and portable
- easily hang a variety of items



Camping Shelf and Cutting Board  
MD100057  
\$149.95



Deluxe Hooked Towel Holder  
MD100090  
\$39.95



Tree Mounting Point  
MD100103  
\$29.95



Camp Rack  
MD100021  
\$49.95



Deluxe Towel Holder  
MD100089  
\$39.95



UltraLight Towel Holder  
MD100082  
\$24.95





# CAMP ORGANIZERS

## Garbage Bag Holder

- sets up in seconds
- lightweight
- damage-free mounting to trees
- easy to use
- firmly holds bag in wind or storms



Garbage Bag Holder  
MD100047  
\$29.95



Tree Hook LIGHTWEIGHT  
MD100015  
\$39.95



# SLINGSHOTS

Unleash your inner kid with Montie Gear's line of high performance slingshots. Used for hunting, home defense and target practice!

## Slingshots

- accurate and powerful
- shoots at 150FPS
- heirloom quality
- waterjet from aluminum for a strong, lightweight frame
- compatible with a multitude of accessories
- accepts flat or round bands
- easy to carry
- handle wrapped in 550 paracord



Y-Shot Slingshot  
MD100023  
\$129.95



Gloveshot Slingshot  
MD100045  
\$189.95





# SLINGSHOT ACCESSORIES

If you are not already the coolest kid on the block, get your hands on the Tactical Y-Shot Slingshot and accessories!

## Tactical Slingshot Kit

- comes with wrist brace and fiber optic sights

## Sights - Iron / Fiber Optic

- lightweight & easy to install
- adjustable for windage and elevation (multi sight only)

## Picatinny Rail Mount

- lightweight & easy to install
- accepts industry standard attachments



Tactical Y-Shot Slingshot  
MD100088  
\$339.95



Multi Sight  
MD100079  
\$79.95

Iron Sight  
MD100080  
\$34.95



Picatinny Rail  
\$50.00



# SLINGSHOT ACCESSORIES

## Adapter Plate

- replaces side plate
- easily customize your Y-Shot and more



Adapter Plate  
MD100078  
\$24.95

## Wrist Brace

- holds a variety of bands
- lets your forearm carry the load



## Arrow Rest

- shoots any size arrow
- small form factor



Wrist Brace  
MD100077  
\$89.95

## Whisker Biscuit

- convert your slingshot to a slingbow
- accurate with genuine whisker biscuit technology



Arrow Rest  
MD100043  
\$13.95



Whisker Biscuit Arrow Rest  
MD100076  
\$129.95





# SLINGSHOT ACCESSORIES

## Breakdown Arrow Holster

- carries 3 breakdown arrows
- attaches to your belt

## Breakdown Arrow

- three piece breakdown for compact storage
- swappable field point & broad head tips
- easy-to-replace fletchings

## Ammo

- 3/8" and 1/2" steel balls
- shooting smooth ammo increases band life

## Replacement Bands

- single band
- double band

Breakdown Arrow Holster - Natural  
MD100086  
\$89.95



Breakdown Arrow  
MD100048  
\$39.95(each)



Breakdown Arrow Holster - Black  
MD100086  
\$89.95



Steel Balls  
3/8" - MD500000  
1/2" - MD500006  
\$6.95



Double Band  
MD500002  
\$12.00



Single Band  
MD500001  
\$7.00

# SLINGSHOT ACCESSORIES

## Belt Clip Magnetic Ammo Holder

- carry steel ammo without a bag
- weather proof / durable / secure

## Holster

- easy snap (quick use)
- integrated belt clip
- band protection
- monogram with your initials

## DIY Y-Shot Slingshot Kit

- paint and wrap paracord yourself
- accepts all Y-Shot accessories

Belt Clip Magnetic Ammo Holder  
MD100081  
\$79.95

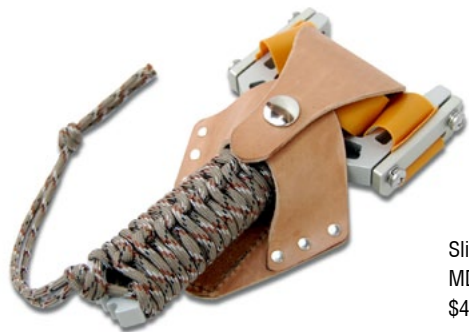
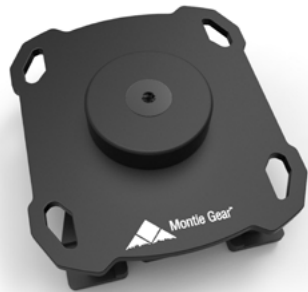

Slingshot Holster  
MD100074  
\$49.95



Black

Natural

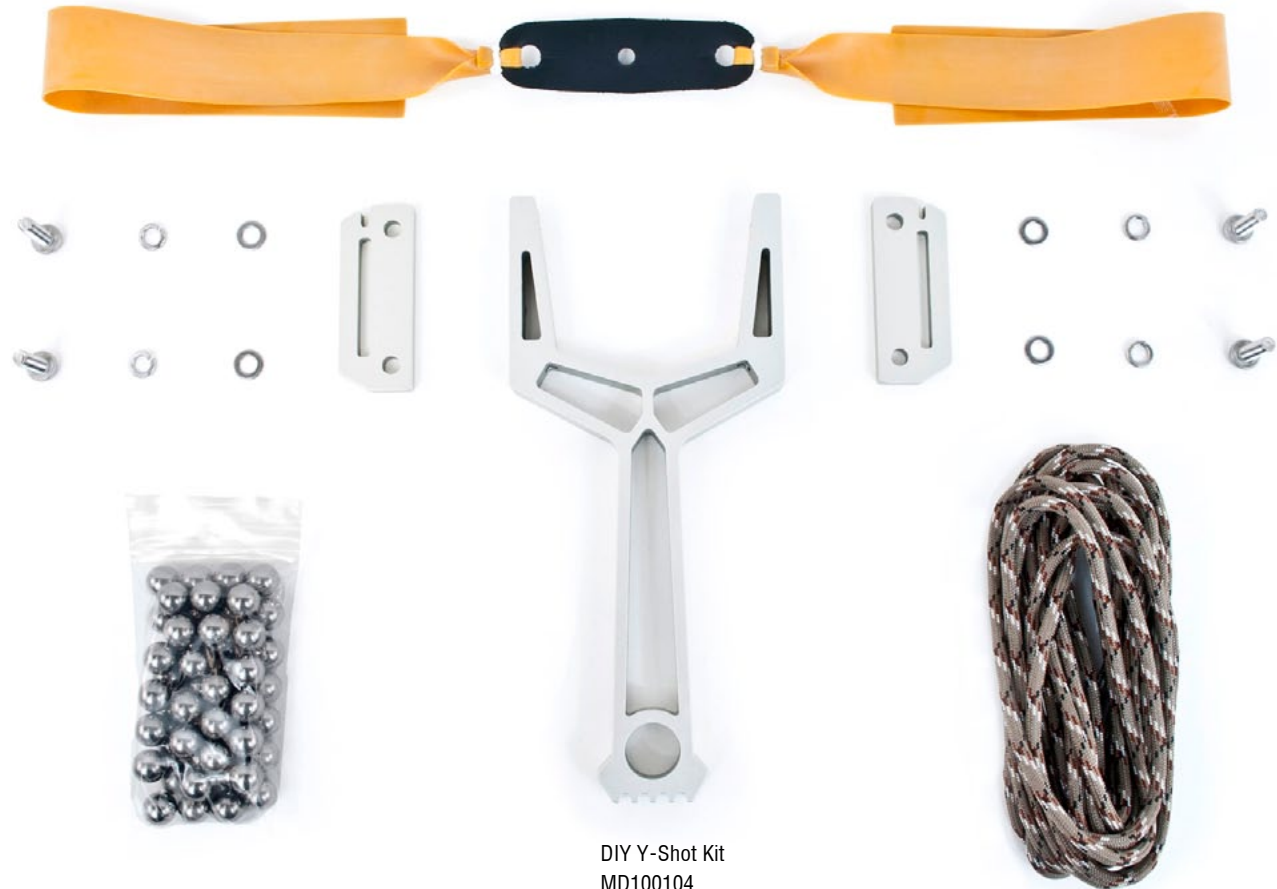

DIY Y-Shot Kit  
MD100104  
\$89.95



# ARCHERY

Be ready for that once in a lifetime shot! The Hunter's Friend provides instant access to your bow or rifle. Great for those long waits in the trees, providing a hands-free experience while positioning your weapon for a quick, stealthy shot.

## Hunter's Friend

- damage-free mounting to trees
- folds flat to approx. half original length
- hold your bow, rifle, rangefinder, binoculars, or other items

## Tree Hook

- damage-free mounting to trees
- waterproof, nonslip surface

Hunter's Friend  
MD100042  
\$179.95



Tree Hook LIGHTWEIGHT  
MD100015  
\$39.95



# KNIVES

A knife ready the moment you need it and light enough to carry all the time. Tanto-style blade is secured into a metal sheath with a unique mechanism that allow instant one handed removal even wearing winter gloves.

## Ultralight Knife

- ultra-lightweight & multi-purpose
- perfect for daily carry or survival situations
- aluminum sheath & stainless steel lock securely holds the knife in place
- CPM 3V blade material
- MOLLE compatible clip belt clip
- clear aluminum anodize or black powder coat finish
- optional paracord-wrapped handle

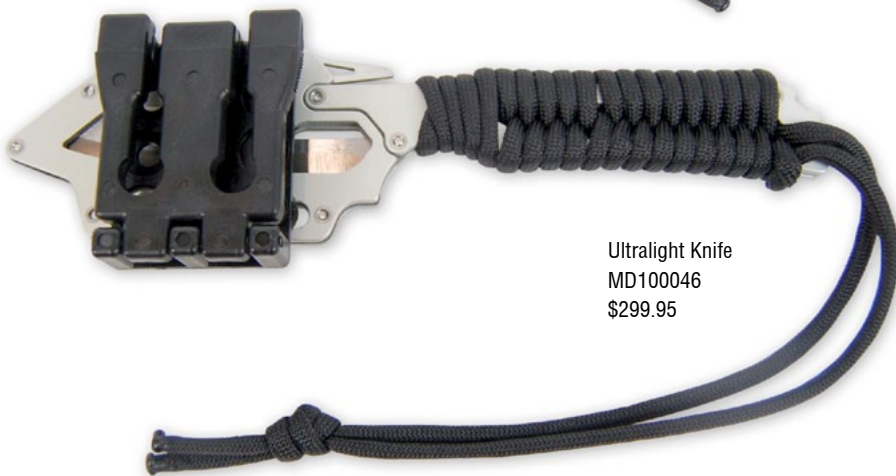

Ultralight Knife  
MD100046  
\$299.95



Ultralight Knife Tactical Black Edition  
MD100046 - TACTICAL BLACK  
\$299.95



## RFID Field Detector

- quickly determine the range of your reader
- 900MHz or 13.56MHz

## RFID Troubleshooting Tool

- find out if your portal is radiating power
- 900MHz

RFID Field Detector  
MD100020  
\$59.95

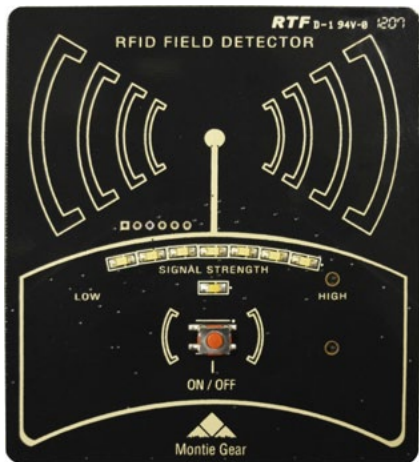

RFID Troubleshooting Tool  
MD100001  
900MHz - \$19.96



RFID Field Detector  
MD100052  
13.56MHz - \$24.95



# EMP BOX

## EMP Resistant Box / Faraday Cage

- protect your electronics from an EMP blast
- 40lbs.
- inside: 15.5" x 17.5" x 13.25"
- custom sizes available
- optional iron or MuMetal lining for protection from strong magnetic fields
- rapid 6-8 week delivery



EMP Resistant Box  
MD100066  
\$2995.95

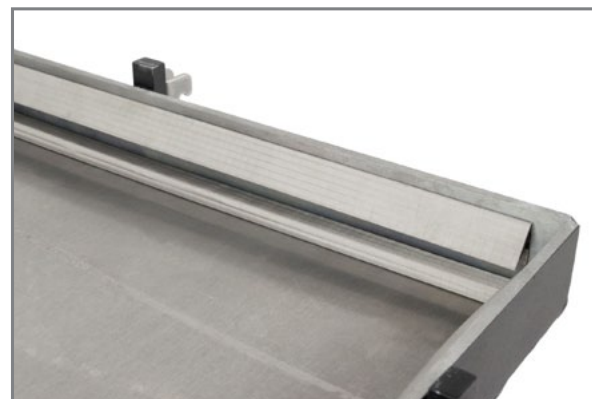





Montie Gear  
100 Dominion Dr., Suite 101  
Morrisville, NC 27560

### **“Montie Gear Over Everything Else”**

Montie Gear products are Heirloom Quality and Troublesome Gap Tough. We pride ourselves in the fact that you can come to North Carolina and meet just about everyone that touched your product from beginning to end. This type of manufacturing intimacy only comes from locally made products, which are rare these days.

“We like the pause that we see when customers first pick up and hold a Montie Gear product, like our Y-Shot. That pause results in a sudden loss of concentration, surprised expression, followed by words like ‘oh that’s nice’, or ‘wow’. There are few greater compliments than the unspoken one that occurs when a customer holds your product and the childlike joy from the quality and feel stops the conversation for a few precious moments” says Montie Roland, President and Founder of Montie Gear.

Look to Montie Gear for outdoor products that make your camping, shooting, or slingshot experience better. Know that your Montie Gear product is the result of the innovation occurring between the Montie Gear staff, enthusiastic interns, and vendors that share the Montie Gear vision of high quality, high performance, well designed products. We won’t let you down.